

Product datasheet

Specifications



Motor circuit breaker, TeSys GV2, 3P, 4-6.3 A, thermal magnetic, screw clamp terminals

GV2ME10

Main

Range	TeSys Deca
Product name	TeSys GV2
Product or component type	Motor circuit breaker
Device short name	GV2ME
Device application	Motor protection
Trip unit technology	Thermal-magnetic

Complementary

Poles description	3P
Network type	AC
Utilisation category	Category A conforming to IEC 60947-2 AC-3 conforming to IEC 60947-4-1 AC-3e conforming to IEC 60947-4-1
Network frequency	50/60 Hz conforming to IEC 60947-2
Motor power kW	2.2 kW at 400/415 V AC 50/60 Hz 3 kW at 500 V AC 50/60 Hz 4 kW at 690 V AC 50/60 Hz
Breaking capacity	100 kA Icu at 230/240 V AC 50/60 Hz conforming to IEC 60947-2 100 kA Icu at 400/415 V AC 50/60 Hz conforming to IEC 60947-2 50 kA Icu at 440 V AC 50/60 Hz conforming to IEC 60947-2 50 kA Icu at 500 V AC 50/60 Hz conforming to IEC 60947-2 3 kA Icu at 690 V AC 50/60 Hz conforming to IEC 60947-2
[Ics] rated service short-circuit breaking capacity	100 % at 230/240 V AC 50/60 Hz conforming to IEC 60947-2 100 % at 400/415 V AC 50/60 Hz conforming to IEC 60947-2 100 % at 440 V AC 50/60 Hz conforming to IEC 60947-2 100 % at 500 V AC 50/60 Hz conforming to IEC 60947-2 75 % at 690 V AC 50/60 Hz conforming to IEC 60947-2
Control type	Push-button
[In] rated current	6.3 A
Thermal protection adjustment range	4...6.3 A conforming to IEC 60947-2
Magnetic tripping current	91 A
[Ith] conventional free air thermal current	6.3 A conforming to IEC 60947-2
[Ue] rated operational voltage	690 V AC 50/60 Hz conforming to IEC 60947-2
[Ui] rated insulation voltage	690 V AC 50/60 Hz conforming to IEC 60947-2
[Uimp] rated impulse withstand voltage	6 kV conforming to IEC 60947-2
Phase failure sensitivity	Yes conforming to IEC 60947-4-1
Suitability for isolation	Yes conforming to IEC 60947-1

Power dissipation per pole	2.5 W
Mechanical durability	100000 cycles
Electrical durability	100000 cycles for AC-3 at 415 V In 100000 cycles for AC-3e at 415 V In
Rated duty	Uninterrupted conforming to IEC 60947-4-1
Connections - terminals	Power circuit: screw clamp terminal 2 cable(s) 1...6 mm ² solid Power circuit: screw clamp terminal 2 cable(s) 1.5...6 mm ² flexible without cable end Power circuit: screw clamp terminal 2 cable(s) 1...4 mm ² flexible with cable end
Tightening torque	1.7 N.m - on screw clamp terminal
Fixing mode	35 mm symmetrical DIN rail: clipped Panel: screwed (with adaptor plate)
Mounting position	Horizontal Vertical
Width	45 mm
Height	89 mm
Depth	78.5 mm
Net weight	0.26 kg
Colour	Dark grey

Environment

Standards	EN/IEC 60947-2 EN/IEC 60947-4-1 UL 60947-4-1 CSA C22.2 No 60947-4-1 IEC/EN 60335-2-40:Annex JJ IEC/EN 60335-1:Clause 30.2
Product certifications	CCC UL CSA EAC ATEX LROS (Lloyds register of shipping) BV RINA DNV-GL UKCA
IK degree of protection	IK04
IP degree of protection	IP20 conforming to IEC 60529
Climatic withstand	conforming to IACS E10
Ambient air temperature for storage	-40...80 °C
Fire resistance	960 °C conforming to IEC 60695-2-11
Ambient air temperature for operation	-20...60 °C
Mechanical robustness	Shocks: 30 Gn for 11 ms Vibrations: 5 Gn, 5...150 Hz
Operating altitude	<= 2000 m

Packing Units

Unit Type of Package 1	PCE
Number of Units in Package 1	1
Package 1 Height	4.500 cm
Package 1 Width	8.500 cm

Package 1 Length	9.200 cm
Package 1 Weight	275.000 g
Unit Type of Package 2	S02
Number of Units in Package 2	24
Package 2 Height	15.000 cm
Package 2 Width	30.000 cm
Package 2 Length	40.000 cm
Package 2 Weight	6.889 kg
Unit Type of Package 3	P06
Number of Units in Package 3	384
Package 3 Height	75.000 cm
Package 3 Width	60.000 cm
Package 3 Length	80.000 cm
Package 3 Weight	116.432 kg

Contractual warranty

Warranty (in months)	18
-----------------------------	----



Environmental Data

Schneider Electric aims to achieve Net Zero status by 2050 through supply chain partnerships, lower impact materials, and circularity via our ongoing “Use Better, Use Longer, Use Again” campaign to extend product lifetimes and recyclability.

[Environmental Data explained >](#)

[How we assess product sustainability >](#)



Environmental footprint

Total lifecycle Carbon footprint	43 kg CO2 eq.
Environmental Disclosure	Product Environmental Profile
Carbon footprint of the manufacturing phase [A1 to A3]	1 kg CO2 eq.
Carbon footprint of the distribution phase [A4]	0.1 kg CO2 eq.
Carbon footprint of the installation phase [A5]	0 kg CO2 eq.
Carbon footprint of the use phase [B2, B3, B4, B6]	40 kg CO2 eq.
Carbon footprint of the end-of-life phase [C1 to C4]	0.7 kg CO2 eq.

Use Better



Materials and Substances

Packaging made with recycled cardboard	Yes
Packaging without single use plastic	Yes
SCIP Number	04104e70-ba29-493c-b2cc-b5837d1f879b

Use Longer



Lifetime extension

Repair	No
--------	----

Use Again



Repack and remanufacture

Recyclability potential, in %	63
End of life manual availability	End of Life Information
Take-back	No
WEEE Label	 The product must be disposed on European Union markets following specific waste collection and never end up in rubbish bins

Performance Curves

Thermal-Magnetic Tripping Curves for GV2ME and GV2P
 Average Operating Times at 20 °C Related to Multiples of the Setting Current

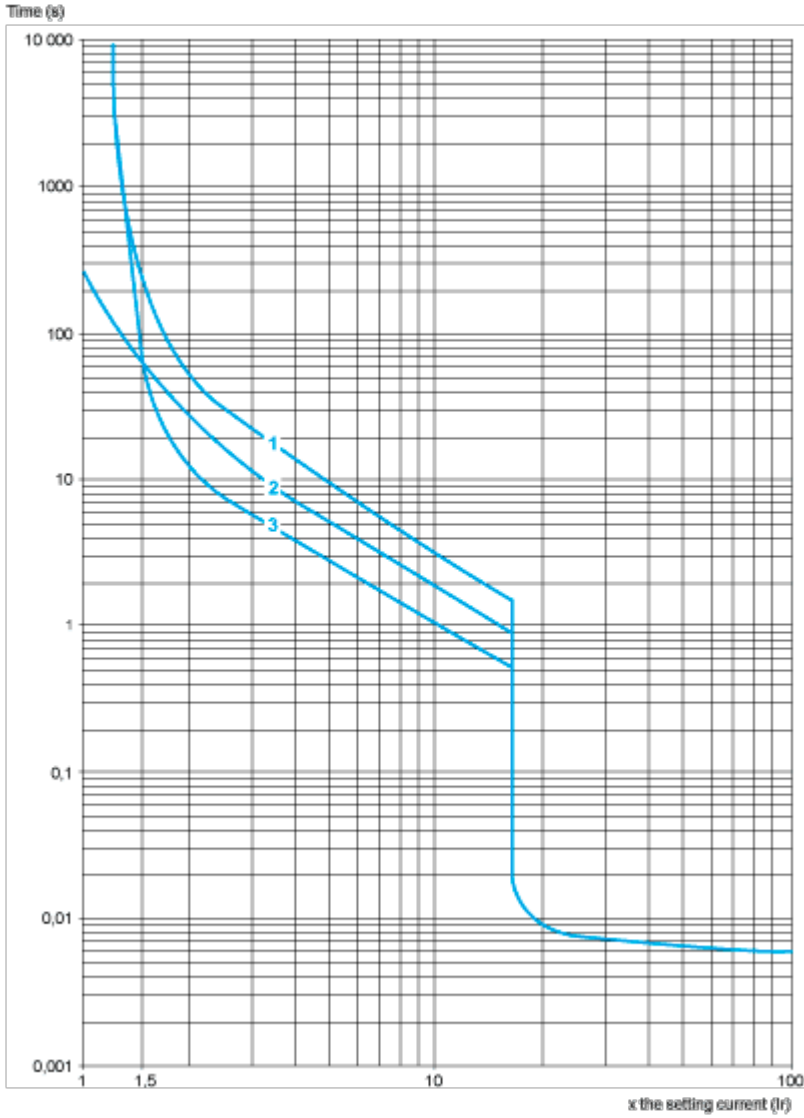

- 1 3 poles from cold state
- 2 2 poles from cold state
- 3 3 poles from hot state

Current Limitation on Short-Circuit for GV2ME and GV2P (3-Phase 400/415 V)

Dynamic Stress

$I_{peak} = f(\text{prospective } I_{sc})$ at $1.05 U_e = 435 V$

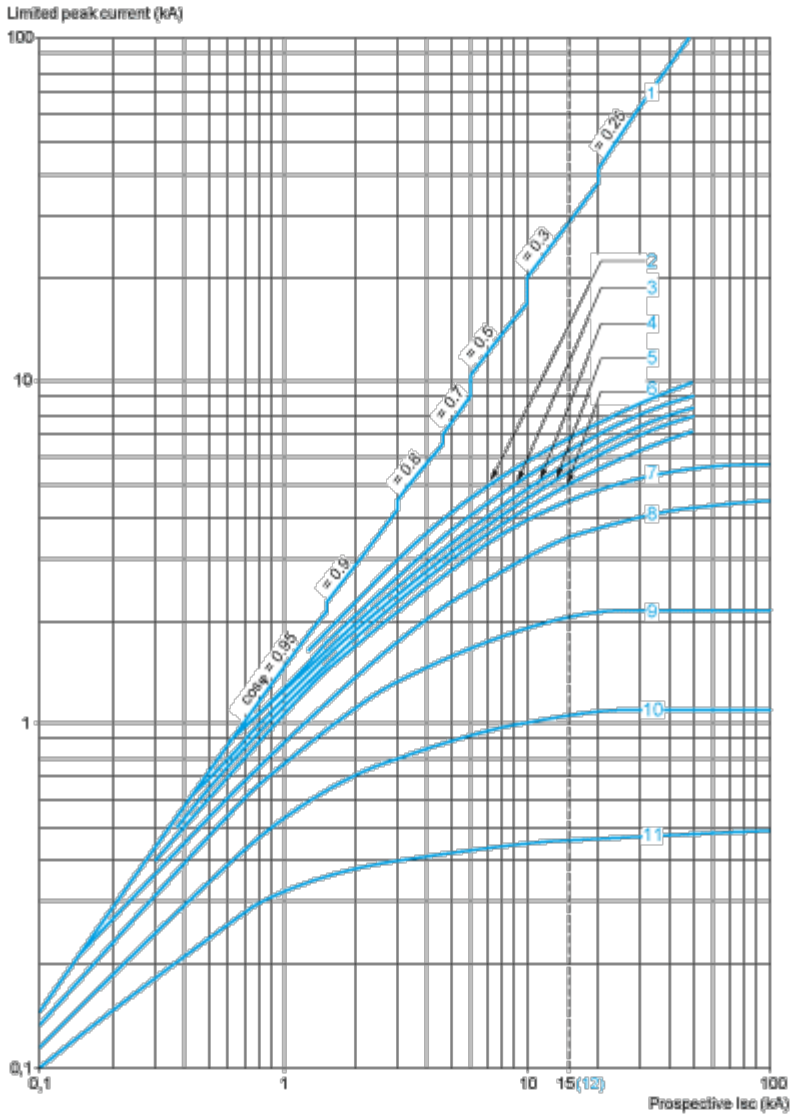

- 1 Maximum peak current
- 2 24-32 A
- 3 20-25 A
- 4 17-23 A
- 5 13-18 A
- 6 9-14 A
- 7 6-10 A
- 8 4-6.3 A
- 9 2.5-4 A
- 10 1.6-2.5 A
- 11 1-1.6 A
- 12 Limit of rated ultimate breaking capacity on short-circuit of GV2ME (14, 18, 23, and 25 A ratings).

Thermal Limit on Short-Circuit for GV2ME

Thermal Limit in kA^2s in the Magnetic Operating Zone

Sum of $I^2dt = f$ (prospective Isc) at 1.05 Ue = 435 V

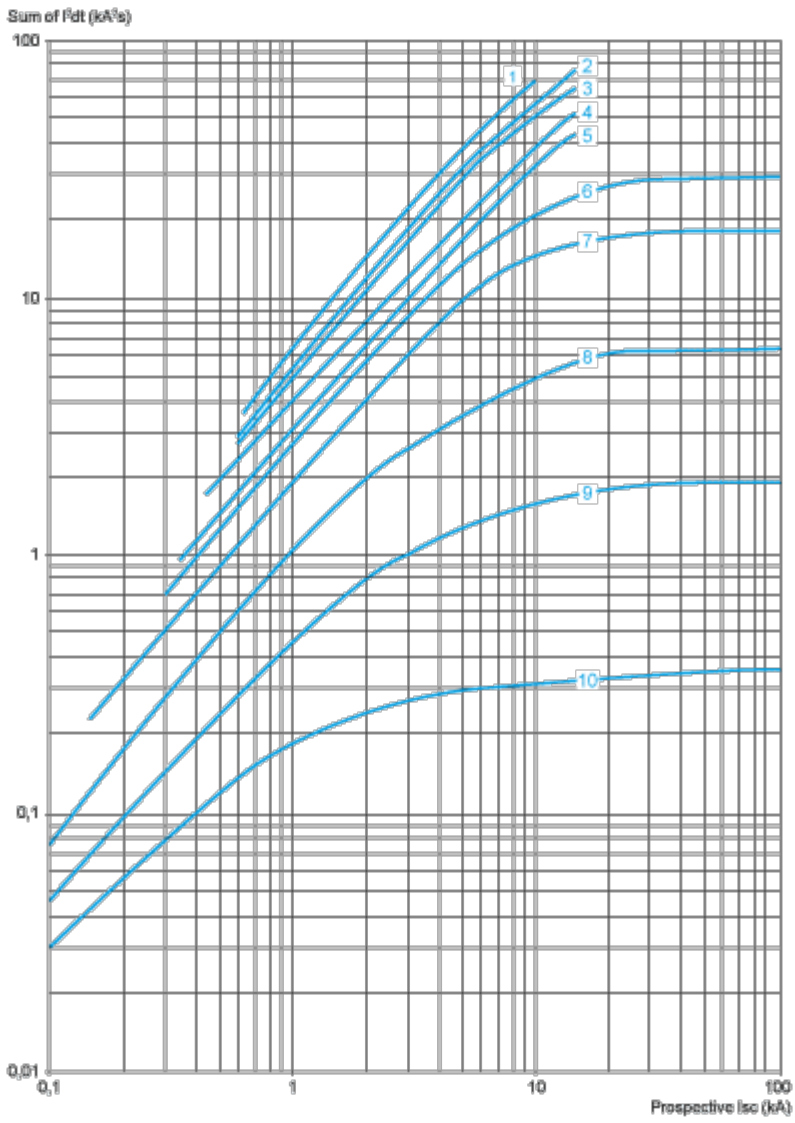

- 1 24-32 A
- 2 20-25 A
- 3 17-23 A
- 4 13-18 A
- 5 9-14 A
- 6 6-10 A
- 7 4-6.3 A
- 8 2.5-4 A
- 9 1.6-2.5 A
- 10 1-1.6 A

Dimensions Drawings

Dimension

GV2ME

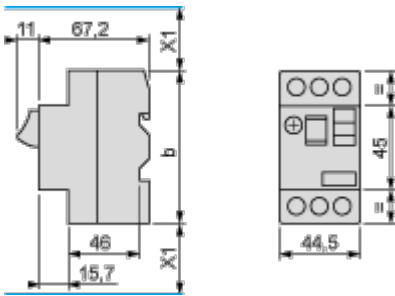

(1) Maximum

X1 Electrical clearance = 40 mm for $U_e \leq 690$ V

	b
GV2ME $\bullet\bullet$	89
GV2ME $\bullet\bullet$ 3	101

Mounting

GV2ME

On 35 mm rail

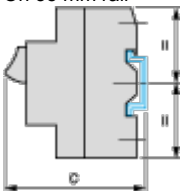

c = 78.5 on AM1 DP200 (35 x 7.5)

c = 86 on AM1 DE200, ED200 (35 x 15)

On panel with adapter plate GV2AF02

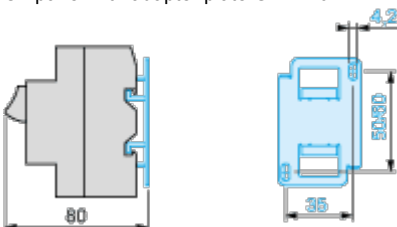

On pre-slotted plate AM1 PA

AF1 EA4

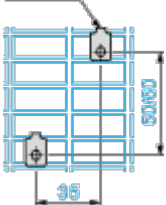

On rails DZ5 MB201

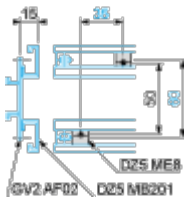

GV2AF01

Combination GV2ME + TeSys k contactor

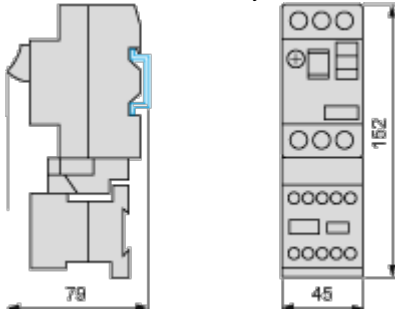

GV2AF3

Combination GV2ME + TeSys d contactor

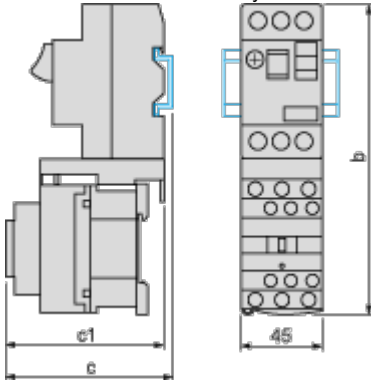

GV2ME +	LC1D09...D18	LC1D25 and D32
b	176.4	186.8
c1	94.1	100.4
c	99.6	105.9

GV2AF4 + LAD311

Combination GV2ME + TeSys d contactor



GV2ME +	LC1D09...D18	LC1D25 and D32
b	176.4	186.8
c1	103.1	136.4
c	135.6	141.9
d1	107	107
d	112.5	112.5

GV2ME + GV1L3 (Current Limiter)

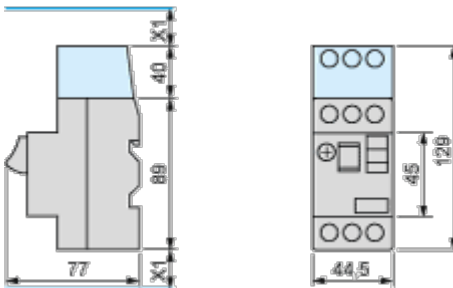

X1 = 10 mm for Ue = 230 V or 30 mm for 230 V < Ue ≤ 690 V

Connections and Schema

GV2ME•• and GV2RT

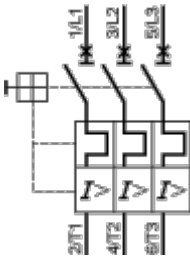

Connection of Undervoltage Trip for Dangerous Machines (Conforming to INRS) on GV2ME Only

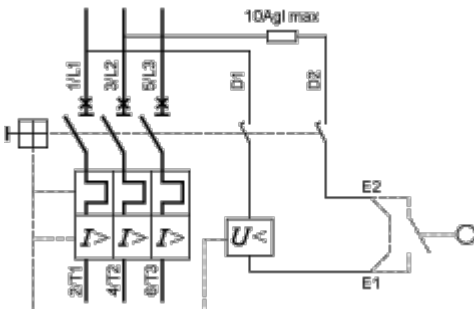

Technical Illustration

Wiring diagram

GV2ME \times

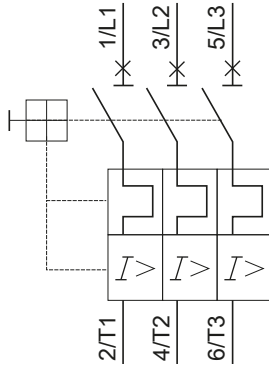

REFER TO TECHNICAL DRAWINGS AND DOCUMENTATION FOR COMPLETE INFORMATION.

Offer Marketing Illustration

Product benefits / Features

TeSys Deca Motor Circuit Breakers

Technical Benefits



- High breaking capacity up to 100 kA.
- Screw clamp for the connection, with lug and spring terminals.
- Easily identify the tripped breaker.
- Padlockable in all versions.
- Sealable thermal overload settings without additional accessories.
- Short circuit indication for better diagnostics when a trip occurs.
- Maximum 15 current ratings to cover from 0.1 A to 32 A motor current with a IP20 level for finger safety.

Offer Marketing Illustration

Product benefits / Features



TeSys Deca Motor Circuit Breakers
Range Accessories

Energy Sensor

Mounting and adapters

Terminal block

Combination block

Motor starter adapter plate

Current limiter

Comb busbar

Auxiliary contact blocks

The image displays a collection of accessories for TeSys Deca Motor Circuit Breakers. At the top left, a large black circuit breaker is shown against a green circular background. Below it, eight different accessory components are arranged in two rows of four. Each component is accompanied by a small text label identifying it: Energy Sensor, Mounting and adapters, Terminal block, Combination block, Motor starter adapter plate, Current limiter, Comb busbar, and Auxiliary contact blocks. The accessories include various electrical components like sensors, mounting brackets, terminal blocks, busbars, and contact blocks, all designed to enhance the functionality and installation of the motor circuit breakers.

Offer Marketing Illustration

Product benefits / Features



The image shows a TeSys Deca Motor Circuit Breaker, a black rectangular device with a red handle. It has three screw terminals at the top labeled 1, 2, and 3, and three at the bottom labeled 2, 4, and 6. A red handle is in the center, with 'OFF' above it and 'ON' below it. To the right of the handle is a green indicator light. The device is set against a green circular background.

TeSys Deca Motor Circuit Breakers

Technical Benefits

- High breaking capacity up to 100 kA.
- Screw clamp for the connection, with lug and spring terminals.
- Easily identify the tripped breaker.
- Padlockable in all versions.
- Sealable thermal overload settings without additional accessories.
- Short circuit indication for better diagnostics when a trip occurs.
- Maximum 15 current ratings to cover from 0.1 A to 32 A motor current with a IP20 level for finger safety.

Offer Marketing Illustration

Product benefits / Features

TeSys Deca Motor Circuit Breakers



Universal Integration

Can be used for all type of applications across industry, infrastructure and buildings.



Complete protection

Provide short circuit protection, overload protection, motor (ON/OFF) control, all in a single product.



Standard Sync

Compliant to motor control and protection, in accordance with standards.



Offer Marketing Illustration

Product benefits / Features



TeSys Deca Motor Circuit Breakers

Range Accessories



Energy Sensor



Mounting and adapters



Terminal block

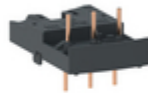

Combination block



Motor starter adapter plate



Current limiter



Comb busbar



Auxiliary contact blocks

Offer Marketing Illustration

Product benefits / Features

TeSys Deca Motor Circuit Breakers



Universal Integration

Can be used for all type of applications across industry, infrastructure and buildings.



Complete protection

Provide short circuit protection, overload protection, motor (ON/OFF) control, all in a single product.



Standard Sync

Compliant to motor control and protection, in accordance with standards.



Image of product / Alternate images

Alternative

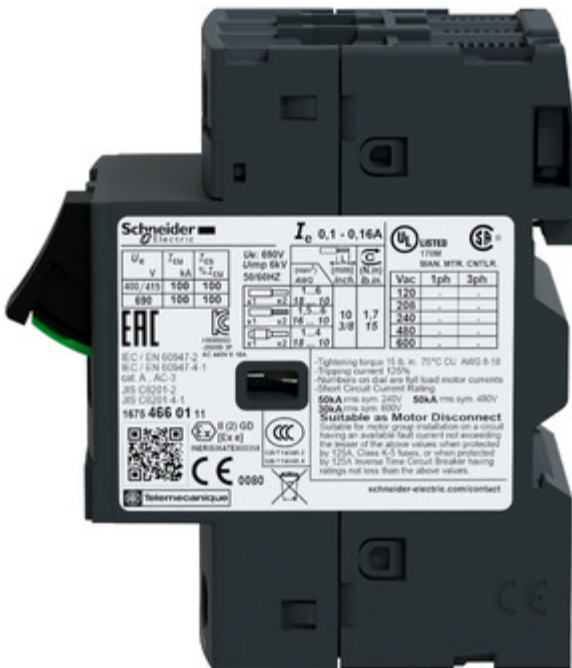
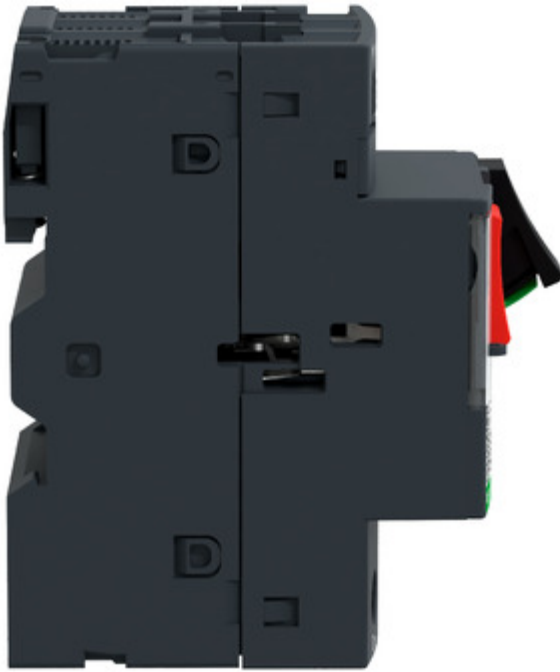

Schneider Electric

I_e 0,1 - 0,16A

UL LISTED 17000
SEAN METL. CNTLR.

U _e V	I _{cu} kA	I _{cs} kA	%I _{cu}
400/415	100	100	
690	100	100	

U_e: 690V
U_{imp} 6kV
50/60Hz

U _e	I _{cu}	I _{cs}	U _{sc}
1.8	10	1.7	15
3.6	10	3/8	15
7.2	10	3/8	15
14.4	10	3/8	15

Lightning torque 15 lb. ft. 70°C CU: 800 8-10
Tipping current 125kA
Numbers on dial are full load motor currents
Short Circuit Current Rating:
50kA rms sym 240V 50kA rms sym 480V
30kA rms sym 600V

Suitable as Motor Disconnect
Suitable for motor group installation on a circuit having an available fault current not exceeding the lesser of the above values when protected by 125A Class K-3 fuses, or when protected by 125A Inverse Time Circuit Breaker having ratings not less than the above values.

schneider-electric.com/contact

